



EURO TERRASSE

Apparu au début des années 2000, le "snacking" - prêt à manger - est en constante évolution.

9 français sur 10 pratiqueraient le snacking (source Ipsos).

Cette gamme répond à cette demande de consommation nomade, rapide et conviviale.



MD 161 P CP

MANGE DEBOUT
PLATEAU Ø 600

PIÉTEMENT Ø 60, ACIER PEINT
RAL AU CHOIX
PLATEAU BAS ACCESSIBLE PMR

VARIANTES : Cendrier en option (CEMD1)

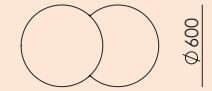
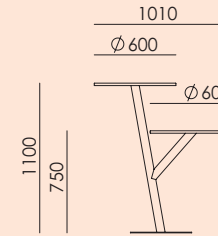

MD 162 P CP

MANGE DEBOUT
PLATEAU Ø 800

PIÉTEMENT Ø 60, ACIER PEINT
RAL AU CHOIX
PLATEAU BAS ACCESSIBLE PMR

VARIANTES : Cendrier en option (CEMD1)

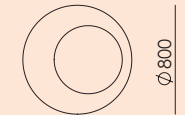
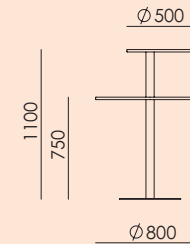

MD 160 CP

MANGE DEBOUT
PLATEAU Ø 600

PIÉTEMENT Ø 60, ACIER PEINT
RAL AU CHOIX

VARIANTE : Cendrier en option (CEMD1)

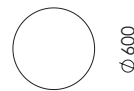
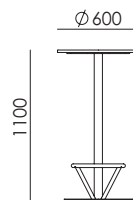

MD 250 CP

MANGE DEBOUT
PLATEAU Ø 600

PIÉTEMENT PLAT 80, ACIER PEINT
RAL AU CHOIX

VARIANTE : Cendrier en option (CEMD1)

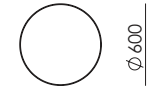
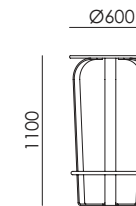

spécial snacking



MD 231 CP

MANGE DEBOUT 6/8 PLACES
PLATEAU 1800 X 520

2 PIEDS ACIER PEINT
PLATEAU COMPACT

VARIANTE : Cendrier en option (CEMD2)

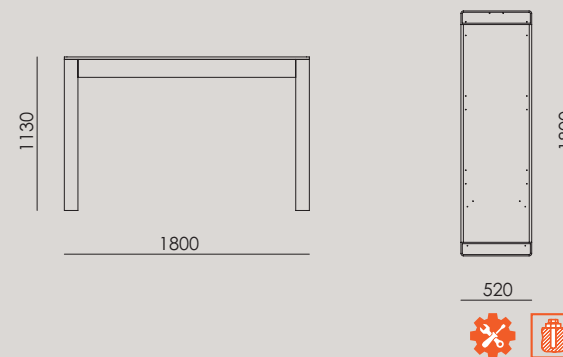

MD 232 CP

MANGE DEBOUT 6/8 PLACES
PLATEAU 1800 X 520

1 PIED ACIER PEINT
PLATEAU COMPACT

POUBELLE INTÉGRÉE (TYPE PFR 100 CP, VOIR DÉTAIL PAGE 54)

VARIANTE : Cendrier en option (CEMD2)

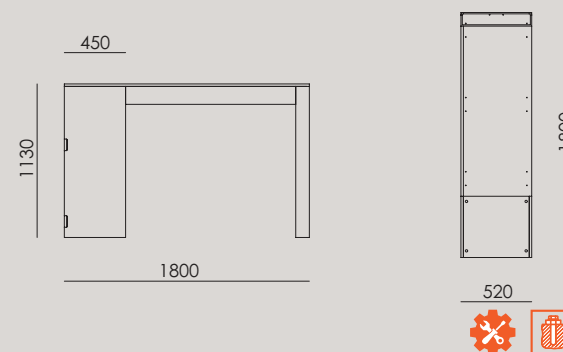

MD 233 CP

MANGE DEBOUT 6/8 PLACES
PLATEAU 1800 X 520

1 PIED ACIER PEINT
PLATEAU COMPACT

A FIXER CONTRE UN MUR

VARIANTE : Cendrier en option (CEMD2)



VARIANTES :

Cendrier en option

CEMD 2



Tabouret haut

TGUH 160 CP
Voir page 18



TABH 240 CP
Voir page 22



TABH 114 CP
Voir page 26

